





1. 適用範圍 / SCOPE

ICP 系列超小型保險絲 · 適用於一般電子設備。
ICP series Micro-Fuse · used in electronic equipment.



2. 產品型號 / TYPE

例「example」：

ICP	T	1A	250V	    
(1)	(2)	(3)	(4)	(5)

(1) 系列號/series Number
(2) 特性符號/Characteristic Symbol
(3) 額定電流/Rated Current
(4) 額定電壓/Rated Voltage
(5) 認證符號/Approved Symbol

3. 額定電流和額定電壓/ RATED CURRENT AND RATED VOLTAGE

額定電流 / Rated Current:

250mA~6.3A

額定電壓 / Rated Voltage:

250VAC

4. 標示 / MARKING

保險絲兩端銅帽上需有下列標示/The fuses cap shall have the following marking

①規 格：額定電流+額定電壓

Specification: Rated Current + Rated Voltage

250mA~6.3A: T _mA/ A 250 _V

②商 標：製造工廠的商標+系列號+認證符號

Trade mark: The Manufacture's Logo +Part Number + Approved Symbol.

250mA~6.3A:  ICP    

注意 / Note :

對標示的大小和位置沒有規定 / Size and position of the markings shall not be provided.

5. 外觀及形狀 / APPEARANCES AND CONFIGURATION

5-1 外觀：不應有破碎、明顯的汗斑。

Appearances: There shall not be break up and any remarkable blotch.

5-2 形狀：帶腳的超小型保險絲。

Configuration: Axial Leded Micro -Fuse.

6. 工程圖和結構 / OUTLINE DRAWING AND STRUCTURE

6-1 工程圖 (單位 : mm) / Outline Drawing and Dimensions (Unit: mm)

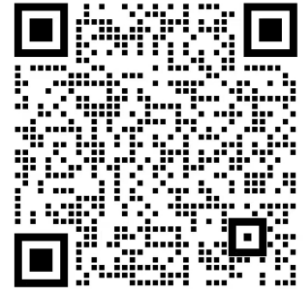
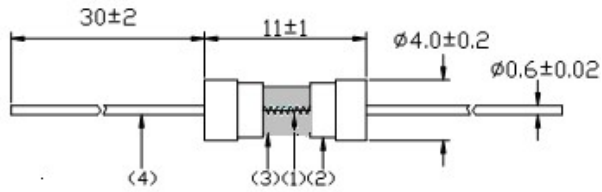

6-2 結構 / Structure

編號 No.	元件 Component	材質 Material	數量 Quantity
①	熔絲 Wire	合金 Alloy	1
②	銅帽 Cap	黃銅鍍鎳 Brass with nickel plated	2
③	本體 Body	陶瓷管 Ceramic Tube	1
④	引線 Lead	鍍錫銅線 Tinned Copper wire	2

7. 特性 / PRODUCT CHARACTERISTICS

7-1 引腳拉力強度 / Lead Pull Strength

10 牛頓 10±1 秒 / 10N for 10±1 Sec.

7-2 引腳推力強度 / Lead Thrust Strength

2 牛頓 10±1 秒 / 2N for 10±1 Sec.

7-3 可焊性 / Solderability

波峰焊/Wave : 260°C · ≤3s;

烙鐵焊/Soldering Iron: 350±10°C · ≤3s.

7-4 耐焊接熱 / Soldering Heat Resistance

波峰焊/Wave : 260°C · 10s;

烙鐵焊/Soldering Iron: 350°C · 5s.

8. 特性 / ELECTRICAL CHARACTERISTICS

8-1 熔斷 / 電流特性 : Pre-Arcing Time / Current Characteristic (limits)

RATED CURRENT	2.1 In	2.75 In		4 In		10 In	
	Max.	Min.	Max.	Min.	Max.	Min.	Max.
100mA to 6.3A	2 min.	400 ms	10 s	150 ms	3 s	20 ms	150 ms

9. 特性 / ENVIRONMENTAL CHARACTERISTIC

9-1 操作溫度範圍: -55°C ~ 125°C / Operating Temperature: -55°C ~ 125°C

若貴司操作環境溫度超出 $25 \pm 5^\circ\text{C}$ 範圍，在選用保險絲規格時，需考慮操作環境溫度對保險絲的影響。
請參照：溫度-電流曲線圖。

When choosing the fuse's specification, if the operating environmental temperature beyond the scope from $20 \sim 30^\circ\text{C}$, you should consider the environmental temperature's affection to fuses.
Please refer:

Temperature-Current curve

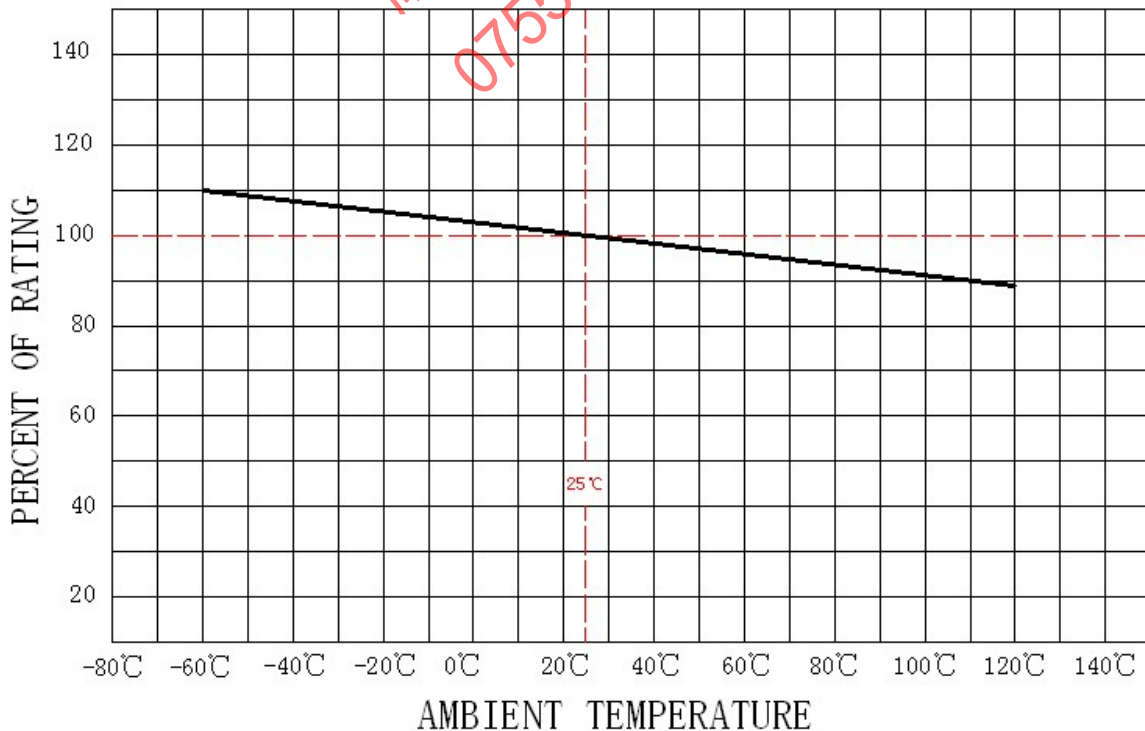

9-2 存儲條件 / Storage Conditions

在溫度+10°C ~ 60°C、相對濕度 $\leq 75\%$ 的密閉條件下可存放 3 年。

Under airtight in temperature+10°C ~ 60°C、relative humidity $\leq 75\%$ can store 3 years.

在溫度相對濕度為 95%的非露天下最多可存放 30 天。

Without at dew relative humidity is 95% maximum value for 30days.

10.安裝方式及條件 / INSTALLATION WAY AND PARAMETERS

10-1 建議如下圖安裝方式安裝，並滿足所要求的尺寸。

Propose that the following picture installation way is installed, and satisfied the required size.

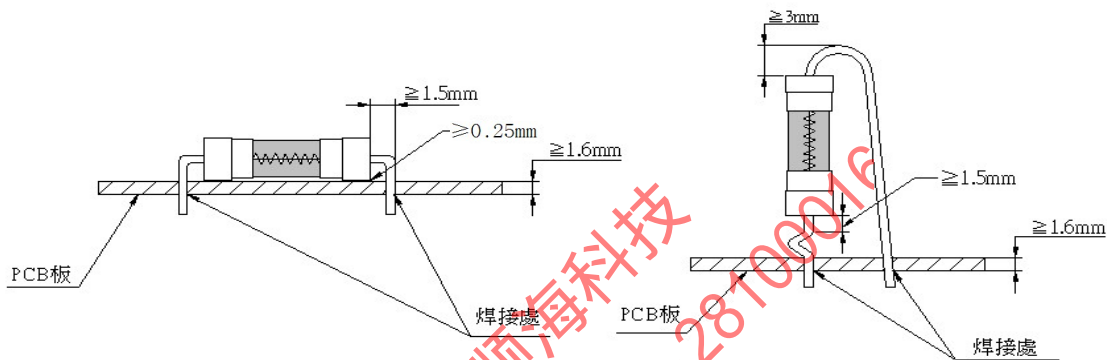

10-2 建議客戶焊接參數 / Recommended Customer Soldering Parameters

波峰焊參數 / Wave Parameters:

錫爐溫度 / Solder Pot Temperature:

260°C Max

焊接時間 / Solder Dwell Time:

2~5s

手工焊參數 / Hand-Solder Parameters:

烙鐵溫度 / Solder Iron Temperature:

350±5°C

焊接時間 / Heating Time:

5s Max

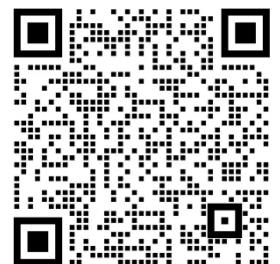

11.其他使用注意事項 / OTHER NOTICE IN USED

如果需在保險絲上加熱縮套管，烘烤溫度與時間需參照以下規定

If need to add heat draws back the sleeve pipe on the fuse , it needs to consult the following regulation to toast temperature and time

溫度 temperature	120°C	130°C	140°C	150°C	160°C	170°C	180°C
時間 time	Max 80s	Max 75s	Max 70s	Max 65s	Max 60s	Max 55s	Max 50s

12.安全認證及編號 / STANDARDS AND APPROVALS

UL	E56092 (100mA~6.3A)
VDE	40012824(250mA~6.3A)
SEMKO	SE-S-2001850 (250mA~6.3A)
CCC	2020970207000233 (250mA~6.3A)
KC	SU05015-6001(250mA~800mA) SU05015-6002(1A~2.5A) SU05015-6003(3.15A~6.3A)

13.包裝 / PACKING

13-1 包裝數量 / Packing Quantity

- A : 每內盒裝 1000 個保險絲。
1000pcs per inner box .
- B : 每外箱裝 20 內盒保險絲。
20 inner boxes per outer box .



13-2 內包裝盒/Inner box of packing

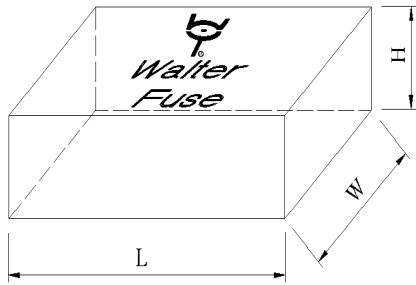

單位/Unit : mm

L	W	H
157±3	124±3	84±2

13-3 外包裝箱/Outer box of packing

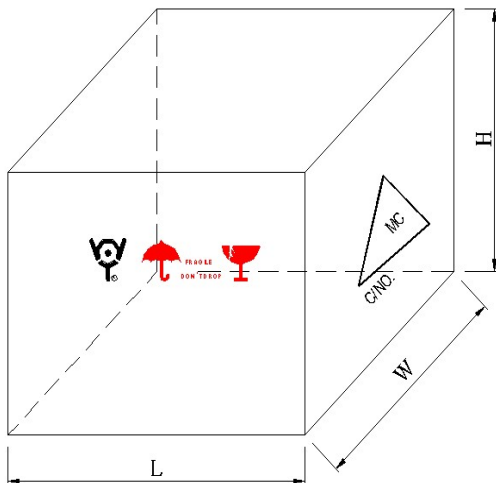

單位/Unit : mm

L	W	H
335±5	451±5	285±5

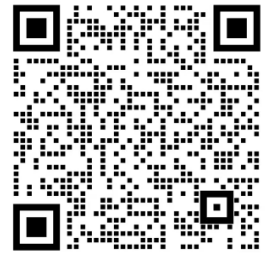

14.其他 / OTHERS

14-1 如果在使用中有超出本規格書的要求，必須經由雙方協商確認。

In the event that an impropriety is found beyond this specification, it shall be fixed by mutual agreement between the parties.

14-2 如果本規格書有不適當的情況，必須通過雙方協商並由本公司修改。

In the event that an impropriety is found in this specification, SUZHOU WALTER ELECTRONIC CO., LTD. shall amend it by mutual agreement between the parties.

版次	製作	確認	審核
第十一版	蔡小梅	徐恩慧	Russel.Hsu



UL iQ for Fuses



Fuses

E56092

Guide Information

SUZHOU WALTER ELECTRONIC CO LTD

NO.99 Xinli Road, Fenhu Technic Development Zone, Wujiang Jiangsu 215211 CN

ICP

Supplemental micro fuses: pigtail leads, cartridge enclosed

<u>Size</u> mm(in)	<u>Amps</u> (A)	<u>Volts</u> (V)	<u>Interrupting</u> <u>Rating (A)</u>
3.6 x 10 (0.14 x 0.39)	0.1 - 6.3	250Vac	50
	0.1 - 6.3	125Vac	50

Report Date: 1994-08-25

Last Revised: 2018-09-04

© 2019 UL LLC



顺海科技
0755-28100016

GUTACHTEN MIT FERTIGUNGSÜBERWACHUNG CERTIFICATE OF CONFORMITY WITH FACTORY SURVEILLANCE

Suzhou Walter Electronic
Co. Ltd.
Fenhu Technic Development Zone
215211 Luxu Town, Wujiang City
Jiangsu
China

ist berechtigt, für ihr Produkt /
is authorized to use for their product

Kleinstsicherungseinsatz
Sub-miniature fuse-link

die hier abgebildeten markenrechtlich geschützten Zeichen
für die ab Blatt 2 aufgeführten Typen zu benutzen /
the legally protected Marks as shown below for the types referred to on page 2 ff.



REG A987 oder/or



oder/or VDE-REG A987

REG A987

Geprüft und zertifiziert nach /
Tested and certified according to

DIN EN 60127-1 (VDE 0820-1):2015-12; EN 60127-1:2006+A1:2011+A2:2015
DIN EN 60127-3 (VDE 0820-3):2015-11; EN 60127-3:2015
IEC 60127-1:2006
IEC 60127-1:2006/AMD1:2011
IEC 60127-1:2006/AMD2:2015
IEC 60127-3:2015

Aktenzeichen: 5000410-1170-0024 / 274200

File ref.:

Ausweis-Nr. 40012824

Blatt 1

Certificate No.

Page

Weitere Bedingungen siehe Rückseite und Folgeblätter /
further conditions see overleaf and following pages

Offenbach, 2005-01-20

(letzte Änderung / updated 2020-07-16)

VDE Prüf- und Zertifizierungsinstitut GmbH
VDE Testing and Certification Institute
Zertifizierungsstelle / Certification

M. Tasotti

VDE Zertifikate sind nur gültig bei Veröffentlichung unter:
VDE certificates are valid only when published on:

<http://www.vde.com/zertifikat>
<http://www.vde.com/certificate>

Name und Sitz des Genehmigungs-Inhabers / Name and registered seat of the Certificate holder

Suzhou Walter Electronic Co. Ltd., Fenu Technic Development Zone, 215211 LUXU TOWN, WUJIANG CITY,
Jiangsu, CHINA

Aktenzeichen / File ref.

5000410-1170-0024 / 274200 / TL3 / EUL

letzte Änderung / updated

2020-07-16

Datum / Date

2005-01-20

Dieses Blatt gilt nur in Verbindung mit Blatt 1 des Gutachtens mit Fertigungsüberwachung Nr. 40012824.

This supplement is only valid in conjunction with page 1 of the Certificate of Conformity with factory surveillance No. 40012824.

Kleinstsicherungseinsatz Sub-miniature fuse-link

Typ(en) / Type(s)

ICP-Series

Bemessungsspannung
Rated voltage

AC 250 V

Bemessungsstrom
Rated current

250mA; 315mA; 400mA; 500mA; 630mA; 800mA; 1 A; 1,25 A;
1,6 A; 2 A; 2,5 A; 3,15 A; 4 A; 5 A; 6,3 A

Normblatt

Die Kleinstsicherungen wurden nach Normblatt IV beurteilt, mit Ausnahme der Abmessungen.
Die Abmessungen der Kleinstsicherungen wurden nach Normblatt II beurteilt.

Standard sheet

The sub-miniature fuse-links were tested according to standard sheet IV with the exception of the dimensions. The dimensions of the samples were judged according to standard sheet II.

Bemessungsschaltvermögen
Rated making and breaking capacity

35 A bzw. $10 \times I_n$
35 A resp. $10 \times I_n$

Kennzeichnung der Charakteristik
Characteristic symbol

T

Zeit/Strom-Charakteristik
Time/current-characteristic

träge
time-lag

Fortsetzung siehe Blatt 3 /
continued on page 3

VDE Prüf- und Zertifizierungsinstitut Gutachten mit Fertigungsüberwachung

Ausweis-Nr. / Blatt /
Certificate No. / Page
40012824 3

Name und Sitz des Genehmigungs-Inhabers / *Name and registered seat of the Certificate holder*

Suzhou Walter Electronic Co. Ltd., Fenu Technic Development Zone, 215211 LUXU TOWN, WUJIANG CITY,
Jiangsu, CHINA

Aktenzeichen / *File ref.*

5000410-1170-0024 / 274200 / TL3 / EUL

letzte Änderung / *updated*

2020-07-16

Datum / *Date*

2005-01-20

Dieses Blatt gilt nur in Verbindung mit Blatt 1 des Gutachtens mit Fertigungsüberwachung Nr. 40012824.

This supplement is only valid in conjunction with page 1 of the Certificate of Conformity with factory surveillance No. 40012824.

Anmerkung
Remark

Ausführung mit Drahtanschlüssen (pigtails).
Construction with lead wires (pigtails).

Dieser Zeichengenehmigungs-Ausweis bildet eine Grundlage für die EG-Konformitätserklärung und CE-Kennzeichnung durch den Hersteller oder dessen Bevollmächtigten und bescheinigt die Konformität mit den grundlegenden Schutzanforderungen der **EG-Niederspannungsrichtlinie 2014/35/EU**.

*This Marks Approval is a basis for the EC Declaration of Conformity and the CE Marking by the manufacturer or his agent and proves the conformity with the essential safety requirements of the **EC Low-Voltage Directive 2014/35/EU**.*

VDE Prüf- und Zertifizierungsinstitut GmbH
VDE Testing and Certification Institute
Fachgebiet TL3
Section TL3

顺海科技
0755-28100016

VDE Prüf- und Zertifizierungsinstitut Gutachten mit Fertigungsüberwachung

Ausweis-Nr. / Beiblatt /
Certificate No. Supplement
40012824

Name und Sitz des Genehmigungs-Inhabers / *Name and registered seat of the Certificate holder*

Suzhou Walter Electronic Co. Ltd., Fenu Technic Development Zone, 215211 LUXU TOWN, WUJIANG CITY,
Jiangsu, CHINA

Aktenzeichen / *File ref.*

5000410-1170-0024 / 274200 / TL3 / EUL

letzte Änderung / *updated*

2020-07-16

Datum / *Date*

2005-01-20

Dieses Beiblatt ist Bestandteil des Gutachtens mit Fertigungsüberwachung Nr. 40012824.

This supplement is part of the Certificate of Conformity with factory surveillance No. 40012824.

Kleinstsicherungseinsatz *Sub-miniature fuse-link*

Fertigungsstätte(n)

Place(s) of manufacture

Referenz/*Reference*
30011941

Suzhou Walter Electronic
Co. Ltd.
Fenu Technic Development Zone
215211 LUXU TOWN, WUJIANG CITY
Jiangsu
CHINA

VDE Prüf- und Zertifizierungsinstitut GmbH
VDE Testing and Certification Institute
Fachgebiet TL3
Section TL3

VDE Prüf- und Zertifizierungsinstitut Gutachten mit Fertigungsüberwachung

Ausweis-Nr. / Infoblatt /
Certificate No. / Info sheet
40012824

Name und Sitz des Genehmigungs-Inhabers / Name and registered seat of the Certificate holder

Suzhou Walter Electronic Co. Ltd., Fenu Technic Development Zone, 215211 LUXU TOWN, WUJIANG CITY, Jiangsu, CHINA

Aktenzeichen / File ref.

5000410-1170-0024 / 274200 / TL3 / EUL

letzte Änderung / updated

2020-07-16

Datum / Date

2005-01-20

Dieses Blatt gilt nur in Verbindung mit Blatt 1 des Gutachtens mit Fertigungsüberwachung Nr. 40012824.

This supplement is only valid in conjunction with page 1 of the Certificate of Conformity with factory surveillance No. 40012824.

Genehmigung zum Benutzen des auf Seite 1 abgebildeten markenrechtlich geschützten Zeichens des VDE:

Grundlage für die Benutzung sind die Allgemeinen Geschäftsbedingungen (AGB) der VDE Prüf- und Zertifizierungsinstitut GmbH (www.vde.com\AGB-Institut). Das Recht zur Benutzung erstreckt sich nur auf die bezeichnete Firma mit den genannten Fertigungsstätten und die oben aufgeführten Produkte mit den zugeordneten Bezeichnungen. Die Fertigungsstätte muss so eingerichtet sein, dass eine gleichmäßige Herstellung der geprüften und zertifizierten Ausführung gewährleistet ist.

Die Genehmigung ist so lange gültig wie die VDE-Bestimmungen gelten, die der Zertifizierung zugrunde gelegen haben, sofern sie nicht auf Grund anderer Bedingungen aus der VDE Prüf- und Zertifizierungsordnung (PM102) zurückgezogen werden muss.

Der Gültigkeitszeitraum einer VDE-GS-Zeichengenehmigung kann auf Antrag verlängert werden. Bei gesetzlichen und / oder normativen Änderungen kann die VDE-GS-Zeichengenehmigung ihre Gültigkeit zu einem früheren als dem angegebenen Datum verlieren.

Produkte, die das Biozid Dimethylfumarat (DMF) enthalten, dürfen gemäß der Kommissionsentscheidung 2009/251/EG nicht mehr in den Verkehr gebracht oder auf dem Markt bereitgestellt werden.

Der VDE-Zeichengenehmigungsausweis wird ausschließlich auf der ersten Seite unterzeichnet.

Approval to use the legally protected Mark of the VDE as shown on the first page:

Basis for the use are the general terms and conditions of the VDE Testing and Certification Institute (www.vde.com\terms-institute). The right to use the mark is granted only to the mentioned company with the named places of manufacture and the listed products with the related type references. The place of manufacture shall be equipped in a way that a constant manufacturing of the certified construction is assured.

The approval is valid as long as the VDE specifications are in force, on which the certification is based on, unless it is withdrawn according to the VDE Testing and Certification Procedure (PM102E).

The validity period of a VDE-GS-Mark Approval may be prolonged on request. In case of changes in legal and / or normative requirements, the validity period of a VDE-GS-Mark Approval may be shortened.

Products containing the biocide dimethylfumarate (DMF) may not be marketed or made available on the EC market according to the Commission Decision 2009/251/EC.

The approval is solely signed on the first page.

CERTIFICATE

FOR EUROPEAN PRODUCT SAFETY

Reference No. SE-S-2001850

Miniature fuse-link

Type designation: ICP

Certificate holder: Suzhou Walter Electronic Co., Ltd.
Fenhu Technic Development Zone
Wujiang, Jiangsu
CHINA

The product complies with the standard(s): EN 60127-3:2015

Date of expiry: 27 September, 2021

EU Directive information: According to the principle of presumption of conformity, this certificate constitutes support for an EC Declaration of Conformity and CE marking according to the Low Voltage Directive 2014/35/EU.

Additional information in Appendix

Certification Body: Intertek Semko AB, Product Certification **Place:** Kista - Stockholm

Signed:  **Date:** 30 June, 2020

Leif Söderlund

APPENDIX:

Reference No. SE-S-2001850

Technical Data:

<i>Type designation</i>	ICP
<i>Rated voltage (V)</i>	250V AC
<i>Rated current (A)</i>	250mA 315mA 400mA 500mA
<i>Standard sheet</i>	Standard sheet 4 in IEC/EN 60127-3 (electrical requirements)
<i>Trademark</i>	
<i>Test Report</i>	1612019STO-001,2020041STO-001
<i>Product information</i>	Time-lag, low-breaking capacity. Size 4 x 11 mm (complies with manufacturer's data sheet). Homogenous series between 250mA - 500mA.

<i>Type designation</i>	ICP
<i>Rated voltage (V)</i>	250V AC
<i>Rated current (A)</i>	630mA 800mA 1,0A 1,25A 1,6A 2,0A 2,5A 3,15A 4,0A 5,0A 6,3A
<i>Standard sheet</i>	Standard sheet 4 in IEC/EN 60127-3 (electrical requirements)
<i>Trademark</i>	
<i>Test Report</i>	1612019STO-001, 2020041STO-001
<i>Product information</i>	Time-lag, low-breaking capacity. Size 4 x 11 mm (complies with manufacturer's data sheet). Homogenous series between 630mA - 6,3A.

Manufacturing Sites:

Suzhou Walter Electronic Co., Ltd.
Fenhu Technic Development Zone
Wujiang, Jiangsu
CHINA

According to the principle of presumption of conformity, this certificate, which includes production control, constitutes support for an EC Declaration of Conformity and CE marking according to the Low Voltage Directive 2014/35/EU.

This presumption can expire before end of validity of this certificate due to new issued Standard or Amendment and changes within the EU legislation.

This certificate replaces previously issued ref. No. 1811348 dated 17 August 2018.
A new certificate has been issued on account of removal of factory.

APPENDIX:

Reference No. SE-S-2001850

Certification Body: Intertek Semko AB, Product Certification

Place: Kista - Stockholm

Signed:

Leif Söderlund

Date: 30 June, 2020

Leif Söderlund



Intertek

强制性认证产品符合性自我声明



自我声明编号: 2020970207000233

苏州华德电子有限公司(生产者) 确认知晓《强制性产品认证自我声明实施规则》以及相关产品强制性认证实施规则的要求, 对本声明承担全部法律责任。

苏州华德电子有限公司(生产者) 声明以下产品已按照《强制性产品认证自我声明实施规则》以及相关产品强制性认证实施规则的要求进行检测, 符合相关标准要求; 自本声明签署之日起, 生产和销售的产品持续符合以下标准与实施规则的要求; 保存本声明涉及的技术文档至少10年; 正确使用强制性产品认证标志; 如产品或其符合性信息发生变更, 将及时更新技术文档并报送产品变更信息。

生产者名称: 苏州华德电子有限公司
生产者地址: 江苏省苏州市吴江区汾湖经济技术开发区(芦墟)
依据的强制性产品认证规则: CNCA-00C-008: 2019 强制性产品认证实施规则自我声明
产品名称: 超小型熔断体
产品系列、型号、规格: (见附页)
依据的标准: GB/T9364.3-2018; GB/T9364.1-2015
生产企业名称: 苏州华德电子有限公司
生产企业地址: 江苏省吴江汾湖经济开发区新黎路99号

顺海科技
0755-28100016

联系人: 杜技伟
电话: 0769-87772561
电子邮箱: td.chiang@walterfuse.com
指定签字人: 杜技伟

自我声明时间: 2020-08-31
自我声明地点: 苏州
生产者签章:

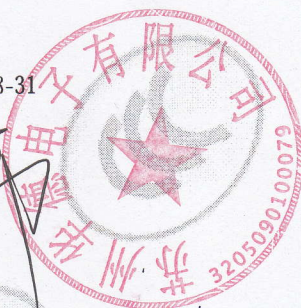

注: 有关本声明信息真伪可登录全国认证认可信息公共服务平台 (cx.cnca.cn) 或扫描右上角二维码查询。

强制性认证产品符合性自我声明(附页)



自我声明编号: 2020970207000233

产品系列、型号、规格:

ICP T250mA250V、ICP T315mA250V、ICP T400mA250V、ICP T500mA250V、ICP T630mA250V、ICP T800mA250V、ICP T1A250V、ICP T1.25A250V、ICP T1.6A250V、ICP T2A250V、ICP T2.5A250V、ICP T3.15A250V、ICP T4A250V、ICP T5A250V、ICP T6.3A250V

顺海科技
0755-28100016

联系人: 杜技伟
电话: 0769-87772561
电子邮箱: td.chiang@walterfuse.com
指定签字人: 杜技伟

自我声明时间: 2020-08-31
自我声明地点: 苏州
生产者签章: 程颖



注: 有关本声明信息真伪可登录全国认证认可信息公共服务平台 (cx.cnca.cn) 或扫描右上角二维码查询。

접수번호 : 06-1920-4478
(Order No.)



전기용품안전인증서

Electrical Appliances Safety Certificate

안전인증번호 : SU05015-6001
(Certificate No.)

제조업자명 : Suzhou Walter Electronic Co., Ltd.
(Factory)

대표자명 : -
(President)

제조공장의 소재지 : Fenhui, Technic Development Zone, Luxu Wu Jiang, Jiangsu,
(Factory Address) P.R. China

제품명 : 소형퓨즈 (Sub-miniature fuse-link)
(Product)

기본모델명 : ICP 250mA
(Basic Model)

정격 : T250mA 250V, 35A
(Rating)

파생모델명 : ICP 315mA, ICP 400mA, ICP 500mA, ICP 630mA, ICP 800mA
(Series Model)

적용기준 : K60127-1, K60127-3
(Standard)

「전기용품안전 관리법 시행령」 제4조제3항의 규정에 의하여 위의 전기용품에 대하여 안전인증서를 교부합니다.

We Issue Electrical Appliances Safety Certification as above product by Article 4 Section 3 of the Electrical Appliances Safety Control Law Operation Rule.

2006년 12월 28일
year month day

kti

한국산업기술시험원
KOREA TESTING LABORATORY



- 첨부 : 1. 안전관리부품 및 재질목록 (List of Critical Components)
(Annex) 2. 기본모델·파생모델의 내용 (General Descriptions of Certified Products)
3. 전기용품안전인증의 변경 현황 (Status of Certificate Revisions)

접수번호 : 06-1920-4479
(Order No.)



전기용품안전인증서

Electrical Appliances Safety Certificate

안전인증번호 : SU05015-6002
(Certificate No.)

제조업자명 : Suzhou Walter Electronic Co., Ltd.
(Factory)

대표자명 : -
(President)

제조공장위치 : Fenhui, Technic Development Zone, Luxu Wu Jiang, Jiangsu,
(Factory Address) P.R. China

제품명 : 소형퓨즈 (Sub-miniature fuse-link)
(Product)

기본모델명 : ICP 1A
(Basic Model)

정격 : T1A 250V, 35A
(Rating)

파생모델명 : ICP 1.25A, ICP 1.6A, ICP 2A, ICP 2.5A
(Series Model)

적용기준 : K60127-1, K60127-3
(Standard)

「전기용품안전 관리법 시행령」 제4조제3항의 규정에 의하여 위의 전기용품에 대하여 안전인증서를 교부합니다.

We Issue Electrical Appliances Safety Certification as above product by Article 4 Section 3 of the Electrical Appliances Safety Control Law Operation Rule.

2006년 12월 28일
year month day

ktl

한국산업기술시험원
KOREA TESTING LABORATORY



- 첨부 : 1. 안전관리부품 및 재질목록 (List of Critical Components)
(Annex) 2. 기본모델·파생모델의 내용 (General Descriptions of Certified Products)
3. 전기용품안전인증의 변경 현황 (Status of Certificate Revisions)

접수번호 : 06-1920-4480
(Order No.)



전기용품안전인증서

Electrical Appliances Safety Certificate

안전인증번호 : SU05015-6003
(Certificate No.)

제조업자명 : Suzhou Walter Electronic Co., Ltd.
(Factory)

대표자명 : -
(President)

제조공장의 소재지 : Fenhu, Technic Development Zone, Luxu Wu Jiang, Jiangsu,
(Factory Address) P.R. China

제품명 : 소형퓨즈 (Sub-miniature fuse-link)
(Product)

기본모델명 : ICP 3.15A
(Basic Model)

정격 : T3.15A 250V, 35A
(Rating)

파생모델명 : ICP 4A, ICP 5A, ICP 6.3A
(Series Model)

적용기준 : K60127-1, K60127-3
(Standard)

「전기용품안전 관리법 시행령」 제4조제3항의 규정에 의하여 위의 전기용품에 대하여
안전인증서를 교부합니다.

We Issue Electrical Appliances Safety Certification as above product by Article 4 Section 3 of the
Electrical Appliances Safety Control Law Operation Rule.

2006년 12월 28일
year month day

ktil 한국산업기술시험원
KOREA TESTING LABORATORY



- 첨부 : 1. 안전관리부품 및 재질목록 (List of Critical Components)
(Annex) 2. 기본모델 - 파생모델의 내용 (General Descriptions of Certified Products)
3. 전기용품안전인증의 변경 현황 (Status of Certificate Revisions)